

Q S X
P E

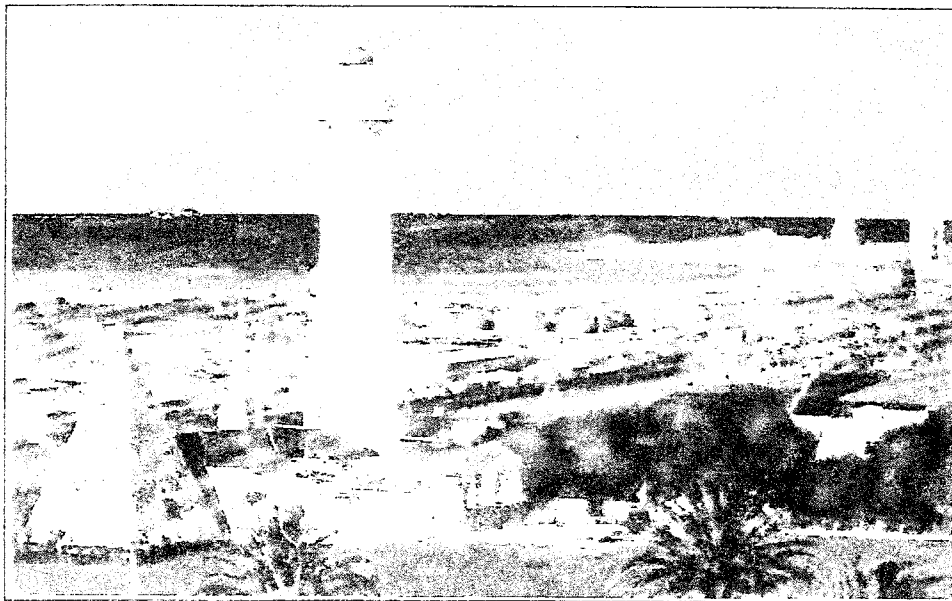

THIS NEWSLETTER IS PUBLISHED BY THE
PORT ELIZABETH AMATEUR RADIO SOCIETY

Web site: pears.8m.com

PO BOX 10402
LINTON GRANGE
6015

May 2002

ANNUAL GENERAL MEETING

The **Annual General Meeting** of the Port Elizabeth Amateur Radio Society will be held in the **Kabega Scout Hall**, van Plettenberg Street, Kabega on **Saturday, 18 May 2002**. Preliminary activities will commence at **15:00 (3.00 pm)**, and the **AGM itself will start at 16:00 (4pm)**.

The agenda appeared in last month's issue of QSX. The Committee has submitted a motion to add a new class of membership in the Constitution to cater for affiliate or associate membership. The text of the motion appears elsewhere.

Starting at 15:00 (and, in fairness to all, not a moment earlier, please!) there will be a **boot sale** in the grounds of the scout hall. This is the opportunity to pass your unwanted junk on to some other dumbo and let *him* cart it away for you.

The meeting will be **followed by a bring-and-braai**, for which the Society will, as usual, provide the fires as well as a few cartons of wine, fruit juice, ice cream and bread rolls.

Please bring your own eats, including salads, and other liquid refreshments as well as utensils, drinking glasses, stools etc.

NOTE THE ADDRESS PLEASE! It's in **KABEGA**, **NOT WALMER** as announced last month. Unfortunately, a double booking occurred and we had to rush around to find an alternative hall just as QSX was about to go to print.

All members and other hams and their families are welcome but, naturally, only paid-up members of PEARS will be allowed to vote.

Wrinkly Ravers

The **next rave** will be on **Thursday, 6 June** at a venue that we have not used before - **Guido's**, in the **Garden Spar complex, Circular Drive, Lorraine**.

Once again a dozen Ravers turned out for the **May get-together** at The Hedges and had a good time. However, after four months it is time to share our patronage around the city again and, since Bill ZS2BY and Joan had enjoyed a recent visit to **Guido's**, it was decided to give that establishment the benefit of our esteemed company in June.

So, see you **at Guido's on 6 June!** Rock up from around noon for a great time.

URGENT REMINDER — Subs are now overdue and this will be the last issue of QSX for defaulters. Please remit your subs right away if you have not already done so.

You can, of course, hand them to the Treasurer before the start of the AGM which will then also entitle you to vote.

If you prefer to pay by bank transfer, you can deposit your subscription in the PEARS account — Nedbank, Port Elizabeth Main branch, a/c no. 2212527594. The branch code is not necessary if "Main" is specified. Please enter your name in the reference blocks on the deposit slip so that Clive knows who it is from. 



The Chairman's Annual Report

Well, it's that time of the year again. Time for introspection and retrospection. Looking back over the past year, PEARS has much to be proud of:

- **QSX**, probably the most widely read ham-mag in the country. For this, our editor Garth ZS2HB must take full credit;
- Another successful **SciFest** exhibition, organised by Neil ZR2NT. André ZS2AJ deserves special mention for again being the 'anchor man' as far as manning the stand is concerned;
- Our **VHF/UHF contest** continues to be well supported, thanks to the efforts of Mike ZS2FM and Al ZS2U;
- The annual **VW rally** came and went, and the excellent commis. that is provided by PEARS has become so routine that it is taken for granted. Many thanks to all those that participated and made it so;
- Amateur radio is all about self-education in matters technical, and perhaps this could be used as a yard-stick of a healthy club. It seems that we measure up, judging by the **technical discussion** heard on our repeaters, mostly on Thursday evenings. For this we must thank the men behind the scenes, Neil ZR2NT and Allan ZS2R for stimulating this activity;
- We are one of the centres with officially appointed **CW examiners**. Thanks to Jim ZS2JF and Al ZS2U for giving of their time and maintaining our standards.
- Our East Cape **linked repeater network** is the standard by which others are judged, and for this we are indebted to Chris ZS2AAW and Trevor ZS2AE. I sometimes wonder if everybody appreciates the skill and time that goes into creating and maintaining such a system. Towards the end of March, the wood-n-iron shack on Lady's Slipper mountain was completely replaced with a good second-hand 'porta-cabin'. It was most gratifying to see how many members arrived on site to lend a hand.
- **Membership** continues to grow and, for that, credit must go to all of our members. The fact of the matter is that people only join an organisation if their perception of the organisation and the people in it is favourable.

With joy there is always some sorrow. This past year we had to say a final farewell to Bryan Haefele ZS2BH, Jack Moolman ZS2KU and Colin Robertson ZS2CR. They all made significant contributions to amateur radio, and we shall not forget them.

Finally, my personal thanks to the outgoing committee for their support freely given. We made a good team.

73 & 88,

Beavan ZS2RL

SARL MATTERS

NOW IS THE TIME FOR ALL GOOD HAMS TO BLOW NEW LIFE INTO THE SARL.

Many of you have cited rising subscription fees as your reason for dropping membership of the League. Many have complained that the League doesn't listen to members. Many have complained of inattention to correspondence. For some it was a "personality" thing. Well, now

SUBS ARE DOWN!!

Ordinary members will pay a low, low R220 (last year it was R265 and the proposed budget for 2003 envisaged a figure of R295). Senior members (pensioners) will pay only R180 as against R200 last year.

To achieve the reduction in subs, the erstwhile holy cow of IARU conference expenditure was unceremoniously slain, even to the surprising (and rather sad) extent of *cancelling our membership* of the international body, of which we were a founder member – at least until we can one day comfortably afford to rejoin. Other possible cuts in expenditure have also been identified.

At the SARL AGM on 20 April, it was refreshing to see that several councillors openly expressed feelings similar to ours. (In the past, there seems to have been great reticence about expressing views different to those of more senior councillors). It became clear that

COUNCIL IS NOW LISTENING!!

Several speakers, including some councillors, stressed the need to get back to basics, even going so far as to hand back to ICASA the tasks that are really theirs and for which SARL has been tacking on charges to cover its own expenses. This would leave more time for HQ staff to attend to correspondence from members. Be that as it may, notice has been taken of the widespread dissatisfaction and you can expect

BETTER ATTENTION TO YOUR NEEDS.

Many ex-members throughout the country have had a problem

over the years with one or other League personality, and this has also now resolved itself. So there really seems to be no reason to withhold your membership any longer on that score.

The bold step of reducing subscriptions was based on the confidence that at least 250 amateurs would join or rejoin the League this year at the lower tariffs. This is essential if the Treasurer is to balance the budget. But your co-operation in this regard will also help to turn the ebbing membership tide, hopefully into a flood of new members with renewed confidence in the SARL, thus restoring the League to its former proud status. So,

NOW IT'S UP TO YOU!!

If you are not a member of the SARL, please consider joining or rejoining right away. If you are already a member, please persuade at least one other person to join the SARL.

Cancellation of our membership of the IARU means that we will no longer be able to approach the IARU for support regarding our licensing conditions or band allocations. The SA Radio League will be on its own in its representations to our licensing authorities. We must therefore urgently increase membership of the League so that it truly represents South African licensees.

Membership of the League is now, more than ever, in your own interests and those of our Society, PEARS.

NOW, MORE THAN EVER, IS THE TIME FOR YOU TO DO YOUR BIT FOR HAM RADIO!!

An application form for membership of the SARL is enclosed. Copies can also be downloaded from the SARL web site, www.sarl.org.za. Those who join now will enjoy immediate membership until 30 June 2003 with all benefits except the May/June 2002 issue of Radio ZS, i.e. the last issue of the current year, although this is available for an extra R15.

It would be interesting to know how many PEARS members have joined or rejoined the League following this appeal, so perhaps you would let us know if you do. E-mail us at glaaks@iafrica.com or tell us at the AGM.

We have already heard of several who have decided to throw in their lot and join up and we thank them for their quick response. 

HAMNET / ECARES NEWS

ECARES Directorate

Only one nomination was received for director of ECARES:

Nominee: Al Akers, ZS2U

Proposer: André Mulder, ZS2AJ

Seconder: Bill Hodges, ZS2ABZ.

Further appointments were made as per ECARES constitution and the directorate for ECARES as from 1st July will be as follows:

Director: Al Akers ZS2U

Deputy Director: Ken Victor, ZS2OC

Assistant Director: Stoffel Carr, ZS2C (Port Elizabeth)

Assistant Director: Matt Wallace, ZS2MW (East London)

Assistant Director: Ralph Hall, ZS2IV (East London)

I would like to thank all those who have assisted me in various ways in the past, too many to mention individually. I really do appreciate it and hope I continue to receive this support. It is after all to our own benefit, to safeguard our lives, the

privileges we have in our hobby and generally.

Social

We were shocked and sorry to hear of the passing of one of our members, Colin Robertson, ZS2CR, and pass on our condolences to his XYL and family.

Colin was a very active ham and he will be sorely missed.

We welcome Tim Joubert ZR2TW to ECARES. It sure is good to see the steady increase in our membership.

John ZS2AH of East London has recently undergone a knee replacement operation and is making good progress.

73.

Al ZS2U

Provincial Director,

Hamnet East Cape/ECARES

!! SUBS ARE OVERDUE !!

Full membership of PEARS costs R50 for the year, Spouse and Student category R30. Subs fell due on 1 April. We hope you will not only renew your PEARS subs but also continue your SARL membership or join/rejoin the League, as the case may be.

Although SARL subs only fall due on 1 July, those joining now will be given full membership immediately right through to 30 June next year for R220 (ordinary member), R180 (Senior) or R55 (Spouse).

It is pleasing to note that several PEARS members have already undertaken to rejoin. The conditions that most ex-members have prescribed for rejoining the League have now been met and there is no valid reason for withholding support any longer.

Even if you qualify for Senior membership but can afford the extra bucks, how about going for *full* membership at R220 and so help just that little bit more to get the League back on track? That's just a tad – 10% – more than the current year's sub. and your goodwill will be appreciated. 

SARL AGM - a turning point!

Replying to an observation by a Sandton member that the meeting was strictly unconstitutional, since the notice and other documents had not been posted the requisite six weeks earlier, the Vice President apologised, saying that the documentation had been held up by printing delays.

The motion before the special general meeting, to amend para. 3.12 of the Constitution to cater for the *incorporation* of other bodies into the League, was carried unanimously.

Arising from the minutes of the previous AGM, I reminded the Chair of the decision at the 2001 AGM that Council minutes should be placed on the web site without delay, not waiting for their ratification at the next meeting. The most recent minutes on the web were those of the October 2001 meeting. After a bit of haggling with the Chairman, he agreed to comply with the decision.

The President, in his annual report, quoted from a letter from ICASA which reminded us that amateurs are expected to be largely self-regulating, i.e. we must ourselves endeavour to maintain proper standards, *inter alia* operating practices, signal quality, acceptable language etc., on our bands and we should speak appropriately to anyone who fails in this regard. (A thought – to avoid unpleasant situations, perhaps each club should designate a representative to handle such matters in their areas – at the risk of his being called a “policeman”, probably by those who most need his attention!)

ICASA also commented on BBSs that are not licensed separately with ZS0 call signs but run under the owners' call signs. ICASA requires such BBSs to be licensed immediately as ZS0 stations. BBS operators must also check on the legality of traffic on their facilities.

Referring to the Bosch ZS2FM report on waning membership, Hans said that the majority of the points have been dealt with on an individual basis. He saw no need to publish the findings in Radio ZS.

IARU Region 1 is now pressing for the

expansion of the 40m band to cover 6,950 to 7,150 MHz. There were moves previously to call for a 300 kHz slot.

Budget, Membership & Fees

Discussion of the budget took hours (the meeting went on until 15:40 without a lunch break) and, on a proposal introduced by Rassie Erasmus ZS1YT, who had the backing of some of the clubs in the Western Cape and other provinces, and Richard Seddon ZS2CLI of Border Radio Club, a number of costly items were removed from the budget or must be cut significantly. Council must also look at other ways to reduce expenditure. Resulting from the proposals, the subscriptions for 2003 were *reduced considerably*. However, it is essential that *at least 250 new members be enrolled*.

The budget for 2002 has been overspent by some R29000 and a proposal was made to cut out the last issue of Radio ZS for the current financial year to help offset this loss. The proposal was turned down. This means that the shortfall must come from the 2003 revenue and that, in turn, requires an even greater influx of new members than a mere 250.

Motions concerning the introduction of an entrance fee and for contravention of the SARL Constitution and Rules by League members to be investigated by branches and clubs were lost.

Amendment of Rule 23.1 (any member of Hamnet, not only an official as originally worded, has to be a member of the SARL) was accepted unanimously. Although I and many others consider it a dumb idea, the point has been argued ad nauseum over the years and was clearly not worth trying once again. But perhaps, one day,

now that many have seen some light...

The remarkable motion about voting rights for clubs bit the dust without much ado.

Two new councillors were elected: Francois Botha ZS6BUU, who is also head of Hamnet, and Karl Canitz ZS1KC.

The proposed Radio Regulations that have been lying on the Minister's table for so long were returned to the League recently – not approved, but for a number of amendments to be made. These seem to be mainly cosmetic, e.g. a matter of terminology. Presumably, after this has been attended to, the documents will once again go on a long, circuitous journey to the Minister's office.

Reference was made to the call book, the numerous errors and outdated entries, and the provision of the home addresses of members who did not want these divulged. Richard, the new Webmaster, informed the meeting that one can now report necessary amendments on the web site and they will be relayed to SARL HQ automatically.

A member was given the floor (and held onto it for some 20 minutes!). The purpose was to ask that HQ be equipped with a packet terminal so that members can communicate with the SARL and receive information from the League by this means. Not all members have Internet facilities, he said. It was pointed out that this had been tried before but it was not successful. He was also reminded that we are not permitted to use amateur radio facilities for messages of business import, and also that the HQ Administrator was not licensed to operate an amateur station. (In any case, I shudder to think of the volume *and content* of messages that would be directed to SARL HQ via packet radio!)

A member echoed wide-spread concern that the SARL's new RAE fee of R250 would deter many potential candidates. He had analyzed the breakdown of the fee as furnished by the

President. However, RAE exam papers were not sent to or returned by each candidate individually by courier, nor did HQ staff run to ICASA separately with each case. He also believed that other elements in the fee were overpriced. According to his calculations, the fee should be no more than about R110. The President promised that this would be looked into.

An Historic Meeting

All in all, this was an AGM that will surely go down in the history of the League as a major turning-point – and just in the nick of time. I was pleasantly surprised to see Councillors at last freely expressing their own views which diverged from the erstwhile 'official' direction taken by the League's Council.

Members, (including Gautengers who attended or were represented at the meeting but who, in the past, generally seemed disinclined to argue face to face with Council), have now at last grabbed back control of the League. That augurs well for the future and one feels confident that things will go better from now on.

PEARS Vindicated

This AGM has also vindicated PEARS in its efforts over the past decade and more to pressure Council to adhere to the straight and narrow, to eradicate the causes of growing dissatisfaction among SARL members and to reverse the distressing downward slide in membership figures.

It's just a pity that other branches (later clubs) failed to understand and support PEARS at one AGM after another, some regarding us as 'stirrers' or 'anti-SARL'. It's a pity that they only opened their eyes when someone else dared to eventually take up the cudgels, when the League was already clearly on its last legs.

Had they supported us years ago, the League would have been well away and prospering today. ☐

PEARS AGM 2002 – Motion by the PEARS Committee

Proposal to amend the rules of the Port Elizabeth Amateur Radio Society:-

Other amateur radio clubs have expressed an interest in becoming affiliated in some manner to PEARS. Including AR clubs and other non-commercial organisations (with a *bona fide* interest in amateur radio or the activities of PEARS) in the definition of 'full member' is the most expedient way of doing this

To give effect to the above, the following amendments to the rules are proposed (new text in bold) –

2. MEMBERSHIP

2.1 Membership shall be open to ~~anyone who~~ **any person or non-commercial club or organisation** that has an interest in amateur radio or the activities of the Society, subject to the approval of ~~his~~ **the** application **for membership** by the Committee. **In the case of a club or organisation, such club or organisation shall enjoy the rights and privileges accorded to an individual person in the category of 'full member'.**

2.1.3 Unless stated otherwise in these Rules, every member shall have the right to participate in debates and vote at Society meetings and to be elected to the Committee. **In the case of a club or organisation, these rights shall be exercised by an individual nominated in writing by the club or organisation concerned.**

FOR SALE ★ WANTED ★ SWOP

FOR SALE

* Kenwood TS-130S all band HF transceiver (including the WARC bands) with handbook and mic. Needs a little attention – R1800 onco — Phil ZS2NP, tel. 082-577-5249. Ralph ZS2IV is disposing of some surplus equipment. The following items are available for sale. Prices are negotiable.

* ICOM 729 HF/6m Transceiver - R2500; ICOM 2410H Dual Band VHF/UHF Transceiver – R2500; ICOM 207 Dual Band VHF Transceiver – R1500; ICOM 2000 VHF Transceiver – R1200; ICOM 229 VHF Transceiver – R1000; MFJ 948 ATU – R800; 12 Element Commercial UHF Beam – R200; Kantronics KAM ver 6 TNC 1200/300 Baud – R500; Digital PC monitor, colour – R400; Trailer (new bearings, wheels and tyres) – R2500 — Ralph ZS2IV tel. 082 954 0409.

WANTED

* 2 Metre base station transceiver, also HF rig – Steve Stevens ZS6AWG in George, tel. 044 871 5195

CORRECTION— In Al's article *VHF DXING & YOUR LOCATION* last month, Ken ZS2BWB's height above sea level was indicated as 10m. It should actually read 20m.

[Not that it's going to help Ken access the satellites any more easily, I guess!]

Al Akers ZS2U

QRP operation, even with a simple antenna, can achieve good results when conditions are good. However, by improving your antenna system, you will be able to make contacts more often and further afield.

The general rule for antennas is the higher the better, for two reasons. The first is so that the antenna is clear of surrounding objects such as buildings, power lines, etc. which will absorb the signal.

Secondly, the higher the antenna the lower the angle of radiation, which is what you need for long-distance operation.

For contacts around South Africa you need *higher* angle radiation, so height is not so important and even a height of three or four metres will work, provided there are no obstructions in the signal path.

Normally it will be better to use a height of at least five metres. For longer distances a height of at least ten metres is recommended.

The easiest antenna to use is a dipole, and length may be calculated from $142.5 / f(\text{MHz})$ metres. A long-wire antenna will also work well, provided that a good ground and a transmatch is used.

If you have the space, a horizontal loop works well. The loop is one wavelength long and may be calculated from $l = 306 / f(\text{MHz})$ metres.

If it is to be used on one band only, a good match can be obtained by using a quarter wave length of 75 ohm line and from there a 50 ohm line.

The quarter wavelength may be calculated from $l = 299,8 \times V / f(\text{MHz})$ metres, where V is the velocity factor of the line (0,66 for coaxial line).

CORRECTION— In Part 1 of this series, published last month, the formula should be amended to read as follows:

$$L = A^2 \times N^2 / 38(A + 3B) \text{ micro-henries,}$$

where:

A = coil diameter in cm

B = coil length in cm

N = number of turns.

Note the insertion of a '3' in the first line.

This antenna may be used on more than one band, making it one wavelength long on the lowest frequency.

There have been several methods of matching proposed, but the only really successful one I have found is to

use an open wire line and a transmatch.

A simple fixed beam made of wire may be tried. Use a folded dipole for the driven element and feed it with 50 ohm coaxial cable. A reflector spaced 0,15 wavelength away and about four to five percent longer than the driven element may be used. Spacing may be calculated from $s = 45 / f(\text{MHz})$.

Antennas is such a wide field that I cannot cover it all in this issue, so if you wish to discuss antennas or have any questions, please contact me.

■ Al can be contacted at tel.

041 360-2983. 

OPERATIONAL AMPLIFIERS Part 2

by Allan Whitehead ZS2R

In part 1 of this series some general comments regarding op amps were made. In this part 2, specific examples will be considered.

One difficulty with op amps is the so-called *offset null*. If the two input terminals of an op amp are short-circuited, i.e. the input is zero, the output will nearly always *not* be zero. The input voltage required to get the output back to zero is called the *input offset voltage*.

Some op amps have a built-in offset null circuit. When a pot. is connected in the specified way, the output level can be adjusted by adjusting the pot. External offset null circuits can be built but they tend to complicate the circuits unnecessarily at this stage.

The inverting and non-inverting inputs of an op amp are usually connected directly to the bases of the input transistors in the op amp and a dc path to ground, albeit a fairly high resistance (100kΩ), from input to ground must be provided.

Always check the output level with a multimeter. For a simple signal amplifier the output should be 0 (ground level) for an op amp using a dual power supply (+V and -V), and for a single supply version (e.g. LM358) it should be half of the supply voltage.

Remember, op amps are direct coupled amplifiers, so any dc voltage on the input will be amplified in the same way as any ac signal. This will be the case in the two examples that follow.

Inverting Amplifier (e.g. 741)

In the circuit that follows, the output level for no input is set on the pot

shown. The input impedance is equal to the value of R1. The gain of the unit is set by the R1 and R2 combination.

$$\text{Gain} = R2/R1$$

The output resistance of most op amps is in the range 1 to 5 ohms.

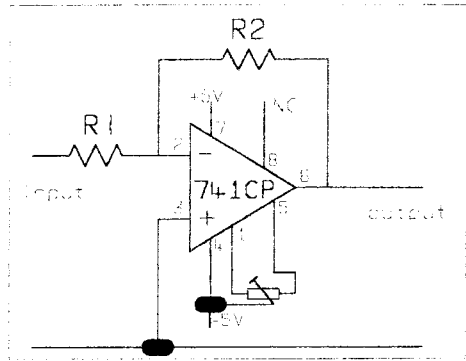

The above amplifier could be used to amplify dc voltages and turn that old 10mA meter in your junk box into a very sensitive voltmeter.

Non-inverting Amplifier

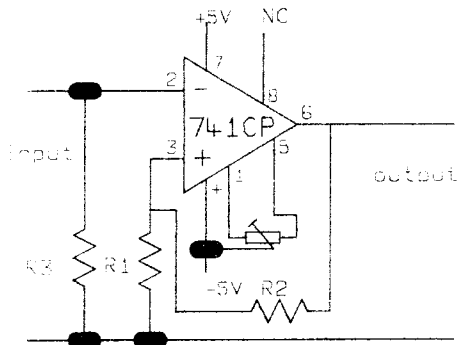

In this case the input impedance will be the value of R3. This can be made 100k to as high as a few megohms.

$$\text{Gain} = 1 + R2/R3$$

Output impedance is again typically a few ohms. ⚡

RF MAGNETIC MATERIALS EXPLAINED

By Hans Kappetijn ZS6KR

(Originally printed in WATTS and RADIO ZS)

Confused by references to **toroid types** and **manufacturer's codes**? Keep this page as your reference.

American manufacturers use the designation **T-xxx-yy** where xxx=hundredths of an inch outer dia and yy=material mix. For example, T-100-2 is a toroid 1,0 inch dia using type 2 material.

Powdered iron mixes: RF applications almost always employ **carbonyl irons** that have moderately low permeabilities (μ) and do not saturate easily. Applications are thus broadband transformers and baluns etc.

Hydrogen reduced irons have higher permeabilities which implies usefulness where high inductances are required such as in power transformers, EMI filters etc. Frequency range is much poorer and similar to **ferrites** which have μ values 150-850 and are composed of either nickel or manganese zinc with a typical working range of 1kHz-1000kHz.

Colour codes identify the mix. Different mixes also differ in temperature behaviour. Check the table below where all important properties are summarized apart from available physical sizes. 

FREQUENCY RANGE	COLOUR CODE	MIX CODE	COMPOSITION	μ	TEMP STAB ppm/deg C
< 1MHz	Yellow-white	26	H-reduced	75	825
0,05-0,5MHz	grey	2	Carbonyl-HP	35	370
0,1-2MHz	Red-white	15	Carbonyl-GS6	25	190
0,5-5MHz	Blue	1	Carbonyl-C	20	280
2-30MHz	Red	2	Carbonyl-E	10	95
3-35MHz	White	7	Carbonyl-TH	9	30
10-50MHz	Yellow	6	Carbonyl-SF	8,5	35
30-100MHz	Black	10	Carbonyl-W	6	150
50-200MHz	Green-white	12	Synthetic oxide	4	170
40-180MHz	Blue-yellow	17	Carbonyl	4	50
100-300MHz	Tan	0	Phenolic	1	0

MINUTES OF THE ANNUAL GENERAL MEETING OF THE PORT ELIZABETH AMATEUR RADIO SOCIETY HELD AT THE KABEGA SCOUT HALL, VAN PLETTENBERG STREET, ON 19 MAY 2001

Welcome: The chairman welcomed all present, particularly those from East London, Port Alfred, Plett, as well as Ian Moore and some new licensees.

Silent Keys: The meeting stood in memory of Owen ZS2AZ, Louis ZS2CB, Van ZS2Y.

Present and apologies: As per register

Minutes of the AGM 13 May 2000 Proposed: ZS2RE, Seconded: ZR2J. No matters arising.

Chairman's report: As published in the May QSX. Notably the growth in membership of 30%. Proposed: ZS2D, Seconded: ZS2CR

Treasurer's report: Proposed: ZS2BWB, Seconded: ZS2CR

Awards:

Appreciation certificates

- RAE lecturers - ZS2HB, ZR2NT, ZS2RE, ZS2JF, ZS2RL
- CW Merit awards for 1000 contacts – ZS2BWB, ZS2RL
- Scifest – ZS2PP, ZR2SC, ZS2AAW, ZS2ABZ, ZS2AE
- ZS2AAW for PEARS web site
- Jim, ZS2LR, for packet BBS sysop
- Al, ZS2U for technical talks and constructional techniques.
- Viv, ZS2VM for help rendered in technical training/evenings
- Isak ZS2ZG, for taking over CW classes
- Cliff Smith, ZS6BOX for service on council.

Achievement award

- Greg, ZS2RE for his RAE manual effort.

Ham spirit trophy

- Andre, ZR2A

DX trophy

- Ken, ZS2BWB

ZS2AB Constructor's trophy

- Phil, ZS2PP

Merit Cup

- Greg, ZS2RE

2m Trophy

- Mike Bosch, ZS2FM

SARL awards presented on behalf of HQ:

- First in single op portable Hamnet contest: Al, ZS2U

Tinus Lange 7066 Technical Excellence Award: Andre, ZS2ACP

Auditor gift: Gus, ZS2MC

Election of chairman

Lionel ZS2DD took the chair. He thanked the outgoing committee for their work done during their past term of office. Nominations for chairman were invited:

Beavan ZS2RL, proposed by ZS2PL, seconded by ZS2VM

Unanimously elected to chairmanship

Election of committee

Beavan thanked the outgoing committee, particularly Trevor who was not available for re-election.

it was then proposed by ZS2MC, seconded by ZS1J, that the previous committee members be re-elected, except for Trevor, ZS2AE who was not available. An additional member was required, for which ZR2NT volunteered his services.

Motions

Ou Toppie award

Requires the age of 80, and also to have been a member for 10 years, and then become exempt from further PEARS annual subscriptions

Proposed: ZS2MM, Seconded: ZS2MC. Unanimously accepted

General

CW examiners

- Beavan mentioned the process of having these re-elected. SARL HQ has become picky in their election of same.
- Bryan, ZS2BH, has equipment for tender, by sealed envelope. Neil, ZS2MG will be handling the process.
- Mike, ZS2FM requests information – he is investigating the loss of members of the SARL – please let him know for what reason they are not members of the SARL. – contributors may remain anonymous.
- Al, ZS2U: Field day contest results were very late. He asks why it seems to have been downplayed. PEARS did well in the contest.
- Ken, ZS2BWB: Feels that PEARS should take the forefront as a collective body to make sure the SARL pleases the membership. Many feel the subs increase is out of line.
- Roger, ZS1J: Garden Route club and Suidkaap club are both struggling, and ask whether they can become “branches of PEARS”. Could the committee please consider this and get back to them.
- Selwyn ZR2KAT: Many Uitenhage chaps are interested. Is there a possibility of classes being held in Uitenhage if they can arrange 6 or more students?
- ZS2HB: Vote of thanks to the SARL for the speed of RAE results
- Phil, ZS2PP: asked for a membership list – Chris indicated that it was available via the web, but a list could be generated for those interested.

The meeting closed at 16h42.

GREG MAYNARD ZS2RE/ZS5RE WRITES:–

Anyone who gets married, goes on honeymoon, moves to a different city and has to find a new home all in one month needs some counselling. I still have to find a good counsellor.

Morag and I had a great wedding and it was nice to have some of the PE ham community there. Unfortunately the weather was not friendly towards us and so we had to make a last minute venue change for the wedding ceremony which, instead of being on the beach, was then held in the Pool Room at the Summerstrand Inn. As Murphy's law would have it, the wind died down at about 6pm.

We took a short break for a few days at the Summerstrand Inn before going home and starting to pack for the move to KZN. One never realises how much stuff one has until one has to pack up and move house.

After box packing we left for honeymoon part one - taking a week to travel through the Eastern Cape and KZN en route to Durban. Honeymoon part two takes place later this year. We arrived in Durban on 14 Jan and then managed to find a very nice (or so I thought) flat in Morningside.

Our furniture took a trip via Cape Town to get to Durban. It arrived on 28 Jan minus the 3 seater couch and a broom, these items being accidentally left in Cape Town. Hopefully we should have our own home before the end of the year and I am going to install an air conditioner in the bedroom.

Please, if any of you visit Durban, give us a call – we would love to see some of the friends from Port Elizabeth. Contact us on 083 654 7283. Cheers. ☺

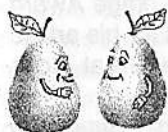

Pearstalk

NEW PRESIDENT FOR SARL

At the council meeting held after the SARL's recent AGM, Sid Tyler ZS6AYC, vice president of the SARL during the previous term, was elected as president. The new vice-president is Dennis Green ZS4BS. Bill Norval ZS5KD remains the secretary and treasurer and he clearly demonstrated that he is well on top of the job.



Outgoing president Hans Potgieter (left) hands over the reins to the SARL's new President, Sid Tyler ZS6AYC.

Two new councillors were elected. They are Francois Botha ZS6BUU and Karl Canitz ZS1KC.

There have been some changes to the council portfolios, details of which will appear in Radio ZS.

PEARS congratulates Sid and Dennis on their appointments and wishes them and the League every success in their endeavours.

Our thanks also go to Hans Potgieter ZS6ALJ, outgoing president, for the

tremendous amount of work that he put in during his term of office, especially considering the travelling that he had to do between his home in Rustenburg and SARL HQ in Johannesburg.

PRESIDENT'S SPEECH AT THE SARL AGM

In his report to the AGM the outgoing president of the SARL quoted the amateur code and deplored the behaviour of many amateurs on the air. He quoted from a letter received from ICASA, reminding us that the amateur service is self-regulatory and that we are all responsible for the maintenance of standards.

He exhorted clubs to take the necessary action where the regulations are infringed. The meeting also recommended that we should all draw an offending operator's attention to this injunction if he behaves improperly or puts out an unacceptable signal. Bad language was specifically mentioned.

The ICASA letter also warned that licence holders, including clubs, are held responsible for what goes through their facilities, both repeaters and BBSs. ICASA said that bulletin board systems on packet radio must be licensed for unattended operation and have a ZS0 call sign.

SHUTTLEWORTH GETS TEMPORARY AMATEUR LICENCE

In a "last minute" effort to obtain an amateur radio licence for Mark Shuttleworth to use during his trip in space, the Oakdale ARC persuaded ICASA to grant a temporary licence with the call sign ZSRSA (no digit) for use only whilst on board the International Space Station.

Arrangements were made with various schools in the country so that learners could speak to Mark and ask him questions.

Some of our local members have had short QSOs with Mark during suitable passes and several have been putting the packet facilities of the ISS to the test.

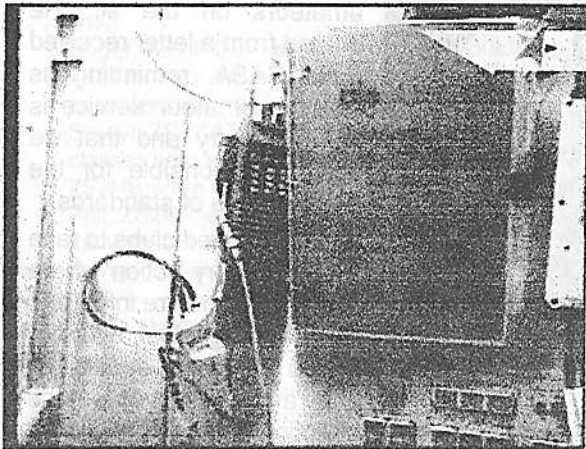

The VHF amateur radio equipment used by Mark aboard the ISS. The packet module is in a separate box.

SARL AWARDS

The following SARL awards were made to PEARS members and the Society itself at the AGM:

- *Jack Twine Award* to Garth Laaks ZS2HB;
- *Arthur Hemsley 2 metre Trophy* to the PE Amateur Radio Society for the Trans-Indian Ocean 2m beacon project between PE and VK;

- *Gary Immelman RA Heritage Award* to Mike Bosch ZS2FM for his article in Radio ZS on "The Great Ross Hull".
- *SARL Hamnet 40m Simulated Emergency Contest*, Single Operator Stationary Mobile: Al Akers ZS2U (second place);

SLIPPER IN NEW CONTAINER

The long-awaited replacement of the repeater accommodation on the Lady's Slipper mountain eventually came to pass. The old faithfuls turned up to help Chris and Trevor first to strip the equipment out of the old shoebox then divvy up the new container and antennas, and finally reinstall everything.

The packet BBS was also affected and Chris took the opportunity to bring the equipment down to his QTH, install upgraded software, and then return everything to the hill.

There seems to have been a glitch or two with the software but it appears to be working OK now – at least, I haven't heard any recent comparing of notes about difficulty in accessing the system.

THANKS

Colin Whitehead ZS2CU thanks all those who helped him to obtain his full ZS call, including overcoming the delays once the upgrade had been approved.

MORE THANKS

As we approach the end of a PEARS financial year, I would like to thank all those who have contributed items for publication in QSX. If your contribution was not printed, it was probably

because of space limitations and the fact that several pages of the Newsletter must necessarily be taken up every month with standard or urgent matter. Sometimes there are items that are topical and cannot be left over. Please don't let that put you off trying again.

Because of the size of QSX, individual articles should preferably be not longer than three A5 pages. Because of the limited readership circle, it is desirable that longish articles be of reasonably wide interest.

Thanks also go to Trevor and Julie Scarr, ZS2AE and ZR2EY, for the collation, folding, addressing and posting of QSX, and to Ashley Goosen ZR2AG for printing the Newsletter at short notice every month.

YET MORE THANKS

My thanks to all the friends who motivated the presentation to me of the Jack Twine Award at the recent SARL AGM. I regard the nomination for the award as a great honour, and trust that whatever I have done to warrant it has really benefited Ham Radio, the League, PEARS and amateurs in general - Garth ZS2HB.

RAE ON 23 MAY

We wish all candidates writing the radio amateur examination on 23 May good luck and we hope to hear them on the bands in the near future.

SPECIAL EVENT STATION

A special station will be operated from 2 to 4 June during the KM Chatham Navy Days exhibition in the Naval Dockyard somewhere in the UK. I received three pages of documentation with a letterhead of the Bredhurst Receiving and Transmitting Society, but nowhere did it say where the dockyard is situated. Presumably it is in Bredhurst. Hopefully the organizers know!

The document says that "the Dockyard has its own special radio call sign that has been allocated to this event" but it does not say what that call sign is! The BRATS holds the call signs G0BRC and G7BRC.

Anyway, they appear to plan to operate on all HF bands and VHF.

PLANETS IN ALIGNMENT

On 8 May, the Earth and seven planets reached a state of close alignment. The phenomenon should still be visible for a few days before the planets disperse once more.

In the sequence in which they appeared in the sky, one could see Mercury, Venus, Mars, Saturn and Jupiter. Although Uranus and Neptune were also in line, they are not visible to the naked eye.

Wonder if radiocommunications were affected? ☐

SOME AUTHENTIC NEWSPAPER HEADLINES TO MAKE YOU THINK

- Cold Wave Linked to Temperatures
- Enfields Couple Stain: Police Suspect Homicide
- Kids Make Nutritious Snacks
- Hospitals are Sued by 7 Foot Doctors
- New Vaccine May Contain Rabies
- Man Struck By Lightning Faces Battery Charge

Recruit a member for the SARL today

Condolences – We were distressed to learn of the sudden passing of Colin Robertson ZS2CR last month. He was a one-time member and Chairman of the Port Elizabeth Branch and more recently of the Border Radio Club. His technical and administrative acumen was put to good use in the ham radio sphere, and he was always ready to help his fellow hams. Our condolences go to his XYL Rosemary ZR2RR and family.

Congratulations...

on your birthdays:

May

- 19 Johannes Pieterse ZR2JLP
- 20 Marjorie Forsyth XYL of ZS2AW
- 22 Saney Martin ZR1S
- 22 Bill Hodges ZS2ABZ
- 24 Vicky Ansell XYL of Allan
- 24 Johan Geyer ZS2OT
- 25 Danie Pretorius ZS2CX
- 31 Shirley Carr XYL of ZS2C
- 31 Joe Jasson ZS2JLJ
- 31 Dennis Flynn ZS2DB

June

- 2 Genis van der Watt ZR2WC
- 5 June Jones ZS2JJ
- 6 Linton Rohl ZR2LIN
- 7 Maria Marran XYL of ZR2AI
- 9 Gus Winter ZS2MC
- 10 Magda van der Merwe XYL of ZS2JC
- 10 Ken Victor ZS2OC
- 11 Maureen Fulton XYL of ZS2MG
- 13 Jimmy Hoole ZS2ABM
- 15 Neville Vroom ZS2NV
- 16 Ian Moore ZR2IJ
- 18 Ingrid Petzer XYL of ZR1DJP
- 20 Jo-anne Durrant XYL of ZS2DI

on your anniversaries:

May

- 20 Magda & Albrecht van der Merwe ZS2JC
- 23 Rouhe & Henry Danielson ZR2HPD
- 24 Denny & Tom Davies ZSL037
- 25 Merle & Neil Thomas ZR2NT
- 31 Del & Neil Bousfield ZR2DR

June

- 4 Marge & Jim van Loggerenberg ZS2LR
- 14 Heather & Jimmy Hoole ZS2ABM
- 16 Peggy & Viv Moore ZS2VM
- 20 Bernice & Bryan Marshall ZS1NQ



Sick List: Anthony Marran ZR2AI had a heart attack and was in ICU for a day or so before being moved to a general ward attached to a lot of plumbing. Hope you're feeling on top of the world again by now, Tony.

Welcome New Member

Johan Moolman ZS6AWL. We're sure you will enjoy your association with us. Johan. 

Your Society's Committee

Chairman, Awards.....	Beavan Gwilt ZS2RI	360-6968
Vice Chairman, repeaters, packet, VW Rally.....	Chris Scarr ZS2AAW	368-1344
Secretary	Chris Scarr ZS2AAW	368-1344
Treasurer; Assets Control	Clive Fife ZS2RI	367-3203
Social, Refreshments.....	Bill Hodges ZS2ABZ	581-2580
QSX Editor	Garth Laaks ZS2HB	368-1101
e-mail the Editor at.....	glaaks@saturn.com	
QSX distribution (ex committee).....	Trevor Scarr ZS2AE	367-1746
Technical Classes, RA1	Neil Thomas ZR2NT	372-1969
Special Events.....	Ewart Bouwer ZS2EHB	933-3482
Science Festival co-ordinator	Neil Thomas ZR2NT	372-1969

PEARS' VHF/UHF & Other Services

REPEATERS

Town VHF.....	# 145.050/650	
Town UHF.....	# 431.050/438,650	
Cockscomb.....	145.000/600	
Colesberg.....	* 431.075/438,675	
Cradock.....	* 145.050/650	
Grahamstown.....	* 145.150/750	
Knysna.....	* 145.075/675	
Lady's Slipper.....	* 145.100/700	
Noupoort.....	* 431.150/438,750	
Uitenhage.....	# 145.075/675	

* These form the PEARS long-range 2-metre repeater system, also linked to which are East London 145.775 MHz, George 145.700, Danabaai 145.600, Stilbaai 145.750, Butterworth 145.725, King Williams Town 145.625 and Umtata (438.725 duplex). It is further extendable to Cape Town via the WCRWG system. # These can also be linked as required.

OTHER SERVICES

Packet Bulletin Board (ZSON1P).....	144.625
Packet Rose Switch ZS0G11-3,046101 (144,675 in/out) or 016102 (UHF out to BBS).....	144.675
2m Beacon (ZS2VHF CW ID, FSK) (horizontally polarized, 160W ERP).....	144.415
6m Beacon (ZS2SIX CW ID) (horizontally polarized, 25W ERP).....	50.005
6m Simplex Link with Lady's Slipper 2m Repeater (vertically polarized).....	51.400
Wefax Relay (Meteosat).....	145.350

Sunday Bulletins

PEARS bulletins are transmitted on Sundays immediately after the SARI English transmission, i.e. at about 08:45, on 7098 kHz as well as the 2-metre linked network that provides coverage from East London to George as well as Cradock and environs. PEARS 7098 or 3640 kHz transceive facilities are also remotely linked as needed. In addition, the SARI's 49m operations on 7082 or 7066 kHz or Hammet's 7070 kHz can be remotely patched into the 2m network in receive-only mode or with full transceive capability for interactive events.

Date	Prepare and Read on 2m Repeater link
12 May	ZS2ABZ
19	Chairman
26	Vice Chair
2 June	Secretary
9	Treasurer
16	Someone else
23	Anyone but me

<u>DIARY DATES</u>
<u>MAY</u>
18 PEARS A.G.M., BRAAI and boot sale
<u>JUNE</u>
6 Wrinkly Rave
21 General meeting

* We Like Being Your Society! *